

The following articles and instructions are provided as general information for enthusiasts working with AMAL carbs on British Motorcycles, without the need for expensive tools or paying for expensive shop labour. Many British motorcycles are not properly enjoyed as the owners have neglected the basics of carb maintenance that they run so poorly and are frustrating to ride. A Norton Commando should idle evenly at 700-800rpm and be able to jump off the line at a traffic light with a fistful of throttle, without hesitation or stalling. Use this information with common sense and at your own risk. There is a lot of technical information available now on the internet about specific settings and components, I would encourage readers to expand their knowledge base by reading as much as possible in this subject. This article is intended to help understand the whys and wherefores and offer guidance to owners who are willing to take on tuning their own motorcycles and enjoy them fully on the road.

### November 2015 Update

Since the original publication of this article back 15 years ago, there has been a change in the gasoline that is available today with the addition of ethanol and other formulations to help emissions in cars. Our vintage and classic motorcycle suffer more than ever from the effects of this ethanol enriched gasoline. The hygroscopic nature of ethanol to absorb water causes rust in our gas tanks creating sediment and also helps increase the amount of scale that builds up in the jets and passages of our carbs. A simple remedy is don't use ethanol gas, but that isn't always possible. So as a matter of regular maintenance be prepared to spend a little time at the start of the riding season to prep and clean your carbs. A fuel injector cleaner product used throughout the riding season will keep things clean. But what I am finding that a good running bike parked for the winter, even with drained carbs, will, when it comes spring time require that the pilot jet be probed and cleaned. It is a simple process and can be done without removing carbs. See my procedure described below. I have added a number of new tips in this article, they are highlighted as **NEW TIP:**

### PILOT JETS EXPLAINED

The number one cause for **poor starting, erratic idle and poor low speed running** is the pilot gas jets are likely to be clogged.

The pilot (or the slow-speed, idle) circuit has three parts:

1. an air passage that is adjustable by the AIR SCREW on the side (coloured in Blue)
2. an internal gas passage with the FIXED pilot jet. This jet is a small brass bushing with a tiny 0.016" (16 thou) orifice that is a press fit in the passage opposite the air adjusting screw. Gas is brought up from the float bowl at the back and travels toward the front (coloured in Red). When it reaches the pilot jet it is metered by the jet orifice before it mixes with the air in the pilot mixing chamber.
3. Pilot circuit mixing chamber (coloured in Yellow) – this is where the metered amount of gas is mixed with the metered amount of air and travels up into the engine through two tiny holes

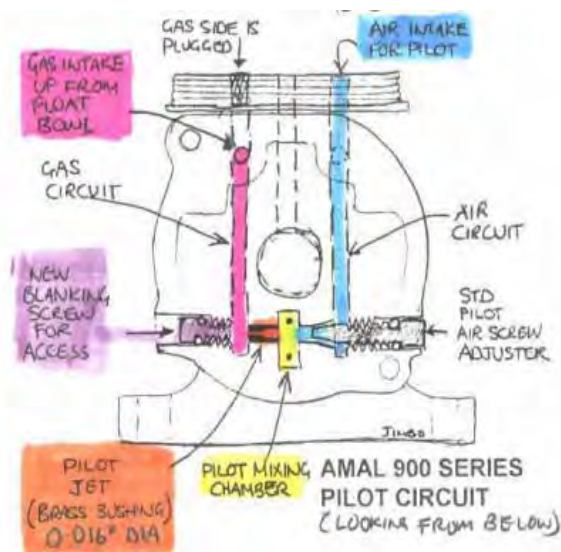

The pilot circuit provides a metered amount of gas and air for idle and low speed running. Think of the gas circuit as an artery - over time the gas passages slowly clog up with scale and varnish from dried gasoline and eventually clog right up. **The only remedy is to physically unclog the jet with a wire probe.**



The pilot jet is drilled 16 thou dia. (0.016"), a very tiny orifice indeed. I use an old guitar string wire with a filed flat end to probe the jet from the air side, after the air adjuster screw is removed (use a flashlight to locate the orifice). Another useful tool is a #78 drill, mounted on an end of small brass or plastic tube, The drill will re-size the orifice, so be careful and make sure all swarf is blown out by compressed air.



Cut away of pilot jet and air mixing chamber. This has the blanking screw modification (see below). The pilot jet itself is the small brass piece on the left of the green mixing chamber

Best to do this on the bench with the float bowl removed so that any scale removed will exit the carb out the orifice on the underside. Make sure the fuel passage on the float bowl is also clear, crud and scale tend to collect on this at the bottom (there are two on each float bowls, one is not used)

Many people say they have soaked the carbs in carb cleaner and blown them out, or have had them ultrasonically cleaned - BUT this will not usually unclog the pilot gas jet, it needs to be physically probed and the scale scraped out.

**NEW TIP - CLEANING PILOT JETS WITH CARBS ON BIKE:**

I have found recently that the pilot circuit needs regular cleaning and I simply do it with the carbs on the bike. You will need a can of carb cleaner, red straw and rubber sleeve, screw driver and the wire probe. Turn off the gas, drain the float bowls if you can, screw in the air screw counting how many 1/2 turns you go (usually 1 1/2 turns), then screw it all the way out and remove. Use the wire probe, with some patience the wire will find the jet, work the wire into the jet, and with pressure push the wire through the jet. I have left my wire long enough so that when the black cover on the wire is at the air screw opening, then I know the wire is all the way through the jet. You should be able to slide the wire back and forth until it meets no resistance. Remove the wire and give the pilot a shot of carb cleaner to blow the swarf back into the float bowl. Reinstall the air screw, all the way in, then back out the same number of turns you counted going in.

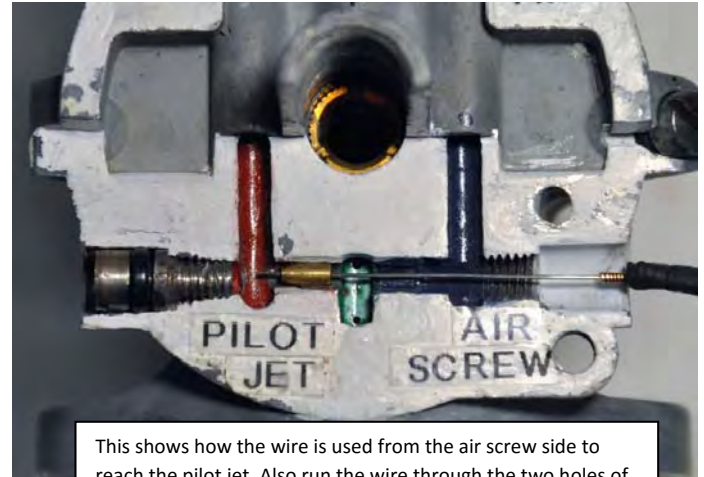

This shows how the wire is used from the air screw side to reach the pilot jet. Also run the wire through the two holes of the mixing chamber making sure they are clear.

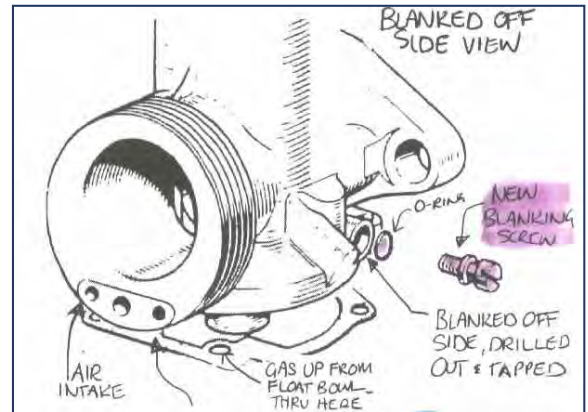

**MODIFICATIONS FOR BLANKING SCREW:**

A useful modification is to actually drill out the blank plug on the opposite side from the air screw and physically probe the jet so that you can see with your own eyes that the jet is clear. The drilled hole is tapped 10/32 (in real life it should be 2BA) and install a blanking plug (an old air adjuster screw cut to size) with Loctite. This is a machinist operation and should not be attempted without the proper tools. This process is a must if you plan to reuse old carbs on a new restoration.

**THROTTLE SLIDES:**

These are the round thingies that slide up and down and over time they wear in the carb body and let air past, particularly noticeable at idle.



One simple test to see if the slides are contributing to the rough running is to hold the throttle at idle and then take up the slack on the cable by slowly turning the throttle - if the idle speed drops, it indicates that the slides are a loose fit in the carb body and should be replaced. As a rule of thumb, slides can be replaced at least once; maybe twice in the life of a carb, they are expensive at around \$30US each, so most people don't think of changing them.

There are also new options with chrome plated brass slides and hard anodised aluminum which are not supposed to wear as fast.

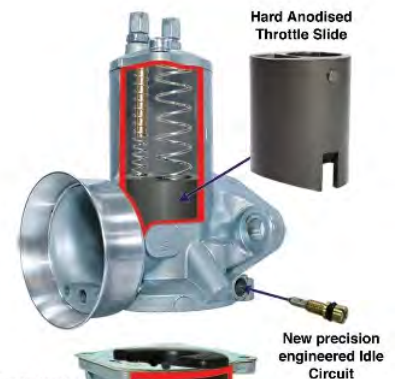

If new slides don't fix the running problem, new bodies can be purchased at a reduced cost rather than buying new carbs. However one should consider that other parts like needles, needle jets can be worn as well and that new carbs maybe the way to go.

Re-sleeving is a viable solution, especially for one off carbs that cannot be easily replaced (Monobloc 689's for instance). Nowadays just about ALL AMAL carbs are available newly manufactured, even the TT's and 276's. There is now also the AMAL PREMIER range of carbs that seem to be the modern updated version with many upgrades.



**CHECKING & SETTING FLOAT HEIGHT:**

Improper float level can be determined by several factors

- fuel leaking out from the gasket joint (too high)
- fuel spilling out the intake holes at the rear into the air cleaner (too high)
- rich running, erratic idle (too high)
- slow to tickle (too low)
- lean running (too low)

There is a very simple method to checking the float height, without special tools or risking the chance of spilling fuel and a fire. This is taken straight from the Triumph Factory Service bulletins. This is how they were set up in the factory and is good enough for general running, including Norton Commandos and BSA's. This setting is good for singles, twins and triples. For down-draught carbs that slope down (i.e. on Atlas), the setting will need to be adjusted higher.

The setting is **080" (80thou) or approx. 2mm BELOW the back edge of the float bowl.** This is the measurement of the TOP edge of the plastic float to BELOW the top edge of the float bowl. Make a scribe mark on the metal float bowl and eye sight the plastic float when the float needle is seated by gently pushing down with a flat blade screw driver in the area next to the brass pivot pin and float needle.

To adjust the seat height, DO NOT try and bend the plastic tab, it has memory and will not stay adjusted. Heat the float bowl on hot water then use a 1/8" drift to move the brass seat in the float bowl itself. It is a tight fit, but can be moved with gentle tapping. Adjust from underside to lower float height, from top side to raise the float level. The Factory suggested heating with a propane torch, but as a measure of safety, I do not recommend this due to gasoline fumes and possibility of explosion.

Remember to replace any of the old white nylon float needles with the viton tipped version

**NEW TIP: STAY UP FLOATS**

A recent product is the new stay up floats from AMAL – these are the black ones with the metal mounting. They are resistant to ethanol and can be adjusted to set float heights by bending the metal tang rather than moving the jet seat in the float bowl method used above.

Due to the age of the original white nylon floats and their unknown performance with modern gasolines, it is becoming common to see these floats discoloured, become brittle and leak (fill with gas) due to pin holes. My theory is new stay up floats are worth the extra cost sooner than later.

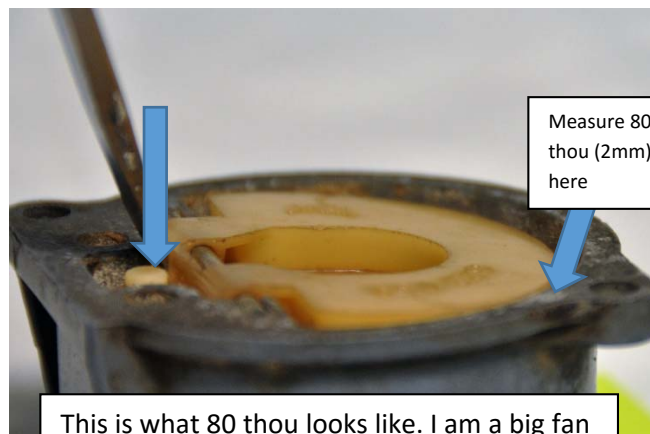

This is what 80 thou looks like. I am a big fan of slightly higher at 50 thou for Norton or Triumph twins

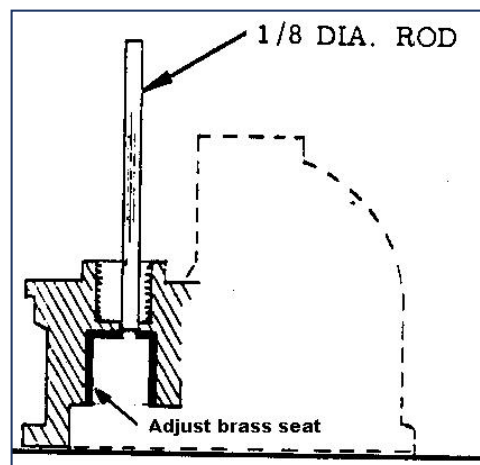

**NEW TIP: NEEDLE JETS AND NEEDLES**

The diagrams below demonstrate the actual operation of the needle, needle jet, throttle slide and main jet

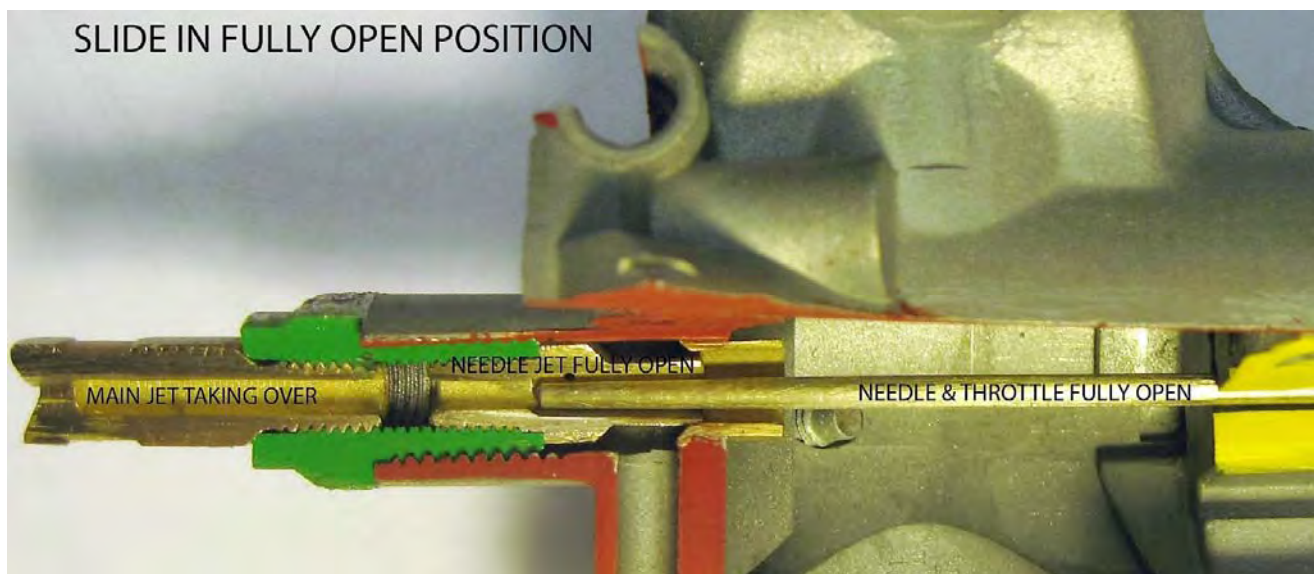
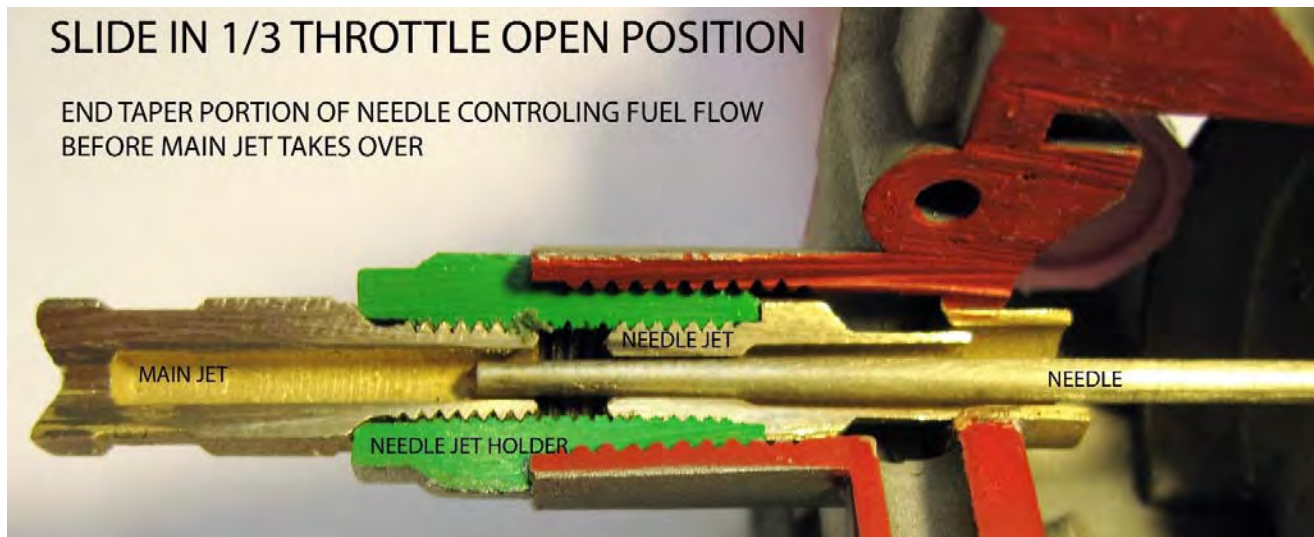
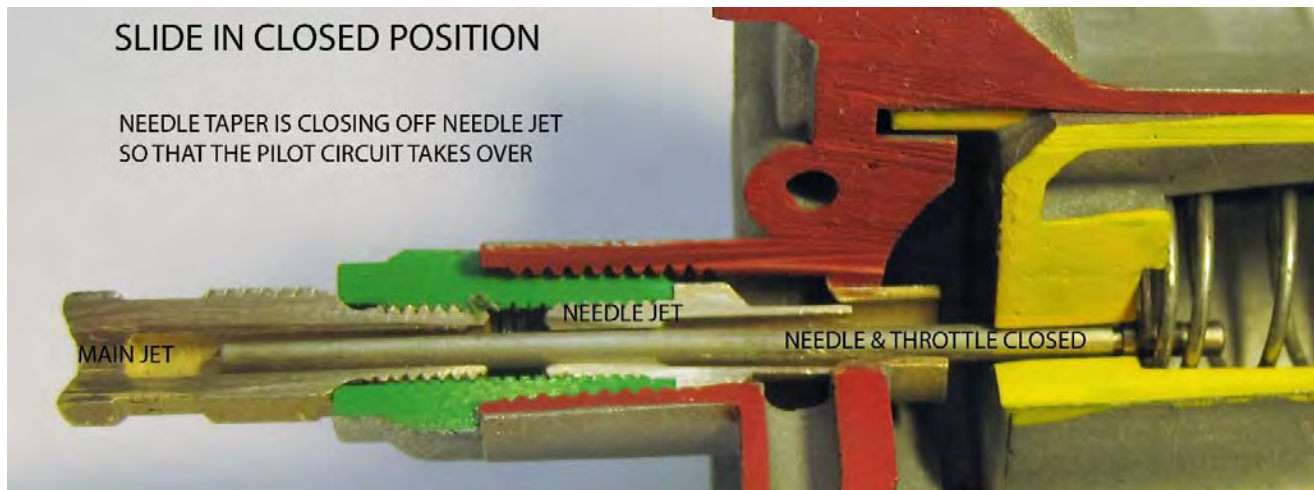

**NEW TIP: NEEDLE JETS AND NEEDLES (continued)**

As carbs cover the miles in use, inevitably the needle jet will wear. The needle jet is the last jet after the main jet for the gas to enter the engine. Every time you open the throttle, the needle which is attached to the throttle slide goes up and down and due to the air velocity of the air passing into the engine, there is slight pressure on one side of the needle which causes it to rub the needle jet. This is a constant activity and the rubbing eventually wear the needle jet orifice oval.

The result of a worn needle jet is evidenced in several ways – the bike no longer runs crisp as the mixture is now running richer than was original specified for, plus the gas mileage increases – more fuel is added, over top of the fuel that is required for proper combustion and is wasted.

As part of the tune up process, or any time the carbs are apart for servicing, it is important to check the wear on the needle jet.

The needle jet specified in almost all of our British singles, twins and triples is a .106 Needle Jet. Thankfully AMAL in their infinite wisdom many years ago translated the jet sizing to correspond with an imperial measurement of the orifice diameter (not cross sectional area as would have been more appropriate for flow). This means simply that a 106 needle jet has a diameter of 0.106" – or if you have a number drill set on hand it would be **#35 Drill**.

I went through a box of spare, "good" Monobloc needle jets with the #35 drill blank end and only two of the six jets were within spec. The drill is really a go-no-go gauge – it will slide smoothly in a spec size jet. In a worn jet you can feel the oversize wobble quite easily.

Make a habit of buying new needle jets. Some claim the needles wear as well, it is possible over a much greater period – I have yet to see a needle showing signs of wear, except in extremely high mileage motorcycles, they get to spin freely when in use.

**SYNCHRONIZING TWIN CARBS FOR IDLE AND SLOW SPEED RUNNING:**

This is one area where there is a lot of misinformation on the process, even in workshop manuals. This will outline the simple methodical professional shop steps to synchronize your twin (or triple) carbs, once all the prep and rebuild work above is completed.

1. Adjust pilot screw to 1 ½ turns out (turn all the way IN till stops then count **1 ½ turns OUT**). This assumes that the pilot gas jet has been cleaned as above)
2. Open the throttle to full open and check that each throttle slide is up the maximum amount (i.e. disappears up into the carb body). Adjust the cable adjusters until an equal amount of throttle slide is seen, just peeking through on each carb. It is surprising the number of bikes I have seen with a major difference in the full open position.
3. Once cables are adjusted for full open, fully turn out the throttle adjusting screws (to past were it touches the throttle slide)
4. Insert two 3/16" dia drill bits (or 4" long piece of round bar) into each carb (diameter size should be adjusted to suit the throttle cut away), seating the drill bit under the throttle slide cutaway, so that they stick out the end of the carb evenly.
5. Screw in each throttle stop screw until the drill bit "dips" a little, find the happy spot, where the screw just touches the slide. Repeat for the other carb. With a felt pen mark the screw head flat-slot position for reference on each carb body.

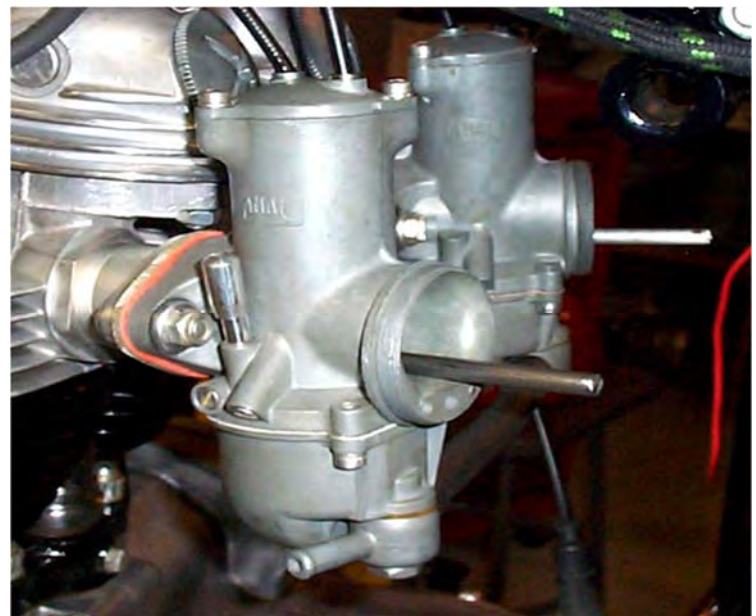

6. With the drill bits still in place, perform the fine cable adjustment - by gently opening the throttle and seeing that each drill bit moves at precisely the same moment. Adjust the cable adjusters on the carb or on each cable so that movement is even (should be only 1/4 - 1/2 turn each) – don't adjust the throttle stop screws in this step.
7. Start the bike, it will likely idle too high, wait for engine to warm up, then adjust each throttle stop screw down (out) by EXACTLY the same amount, i.e a 1/4 turn at a time on each, using the felt pen reference mark to make sure the adjustments are same. The idle should be even and by blipping the throttle the pick-up should also be even.
8. The pilot jet air screw may be adjusted at this time, but by very little, no more than 1/2 to 3/4 turn in either direction. The effective range of adjustment for the pilot jet is 1 turn to 2 turns. This is where a bit of skill & experience comes into play. By turning one screw a little at a time with the engine running (on both cylinders) you can gauge any difference in running and find the sweet spot. When you hear the engine revs race, you want to turn it back a 1/8 to 1/4 turn - the sweet spot is not at the extreme. The idle may need to be dropped equally again.

If you have to screw it in all the way or out all the way, then the pilot circuit is still clogged, maybe not completely, but enough to affect the running. Go back and clean the jet.

### Jetting Chart

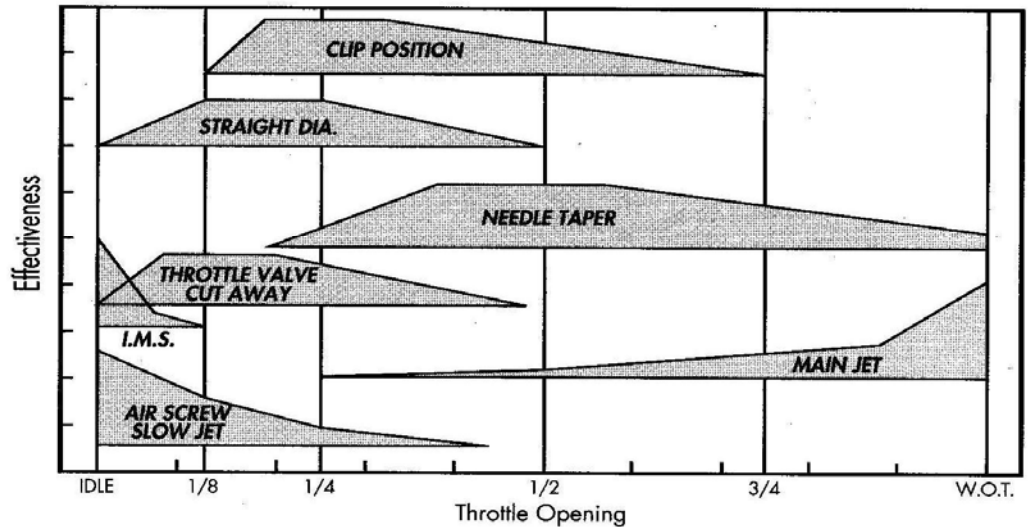

#### TUNING & JETTING CHART:

The following chart shows clearly how the carb components interact and the effective range of adjustments.

You can clearly see that the idle to 1/4 throttle there are a lot of settings coming into play. When one circuit is faulty, it has a carry over to the rest of the range.

#### TUNING BY ROAD TEST

The process of road testing and fine tuning is simple. Firstly get it running. Do the wide open throttle (WOT) test in say 3rd-4th gear and plug chop - change main jets to get desired plug colour (light tan, not chocolate brown) and performance. The pilot circuit (IMS, idle mixture screw and the air screw) is next - make adjustments so that there is no hesitation when the throttle is blipped or blubbing when at low speed. Adjustments can also be made to needle clip position to fine tune mid-range. Changing throttle slide should not be necessary.

THIS ARTICLE MAY BE USED IN CLUB PUBLICATIONS WITH AUTHOR ACKNOWLEDGEMENT

Jim Bush, Vancouver, BC CANADA, [jim@jba.bc.ca](mailto:jim@jba.bc.ca)

Last Updated on November 7, 2015

AMAL's version of the stages of influence of the various throttle position openings

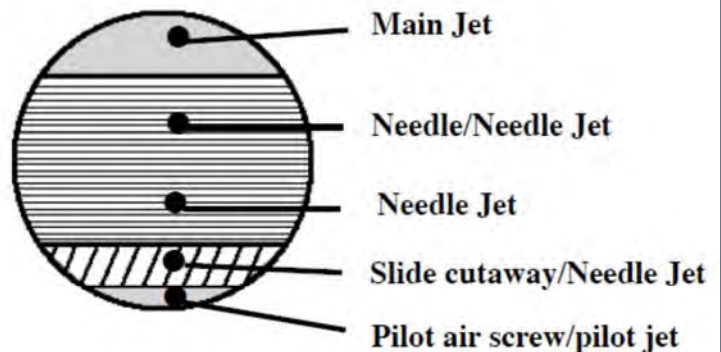

#### Five Stages Of An Amal Carburetor:

Stage one:	Idle to just off idle	Pilot air screw and pilot jet
Stage two:	0 to 1/4 Throttle	Slide cutaway #2 Rich to #4 Lean
Stage three:	1/8 to 1/3 Throttle	Needle Jet
Stage four:	1/4 to 3/4 Throttle	Needle and Needle jet combination
Stage five:	3/4 to Full Throttle	Main Jet